

Article number: 5425061002

Description: 2 hole Flange Unit KFL002 for shaft $\varnothing 15\text{mm}$
Housing alu, bearing steel, extra small

Measures

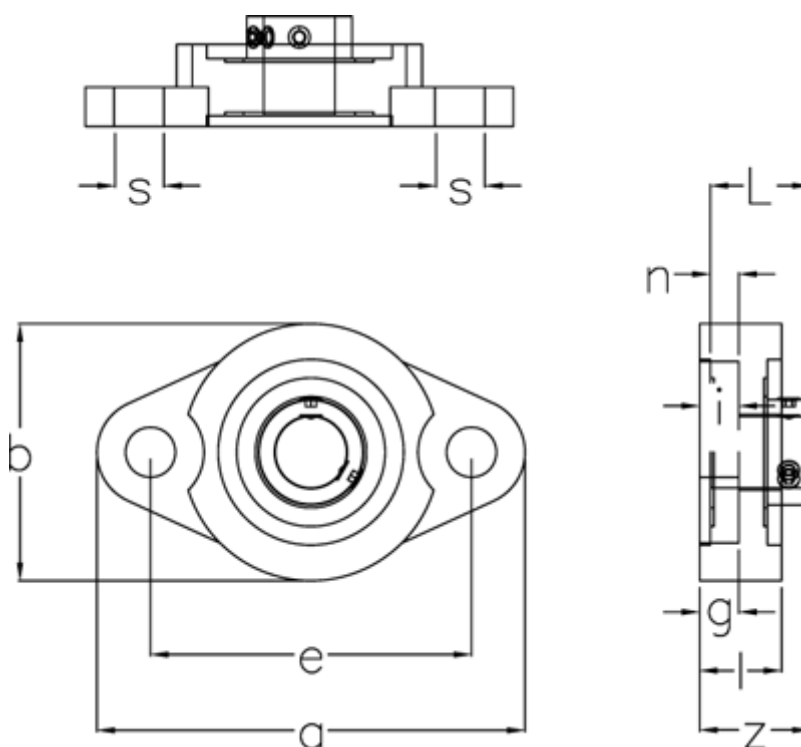

a	= 67	l	= 13.0
b	= 42	L	= 16.5
Bearing	= K002	Nominal drive	= 4.5
Bolt size	= M6	s	= 7
e	= 53	Weight	= 0.11
g	= 6.5	z	= 18.6
Housing	= FL002		
i	= 6.5		